

Name	VS44_0357 500x400/44		
Zeichnung/Drawing	3D	VS44_0357	
Profil/Profile	4.4x13.5	Maßstab/Scale	1:30
		Druck auf/ Print on	A3
		Datum/Date	06.04.2026

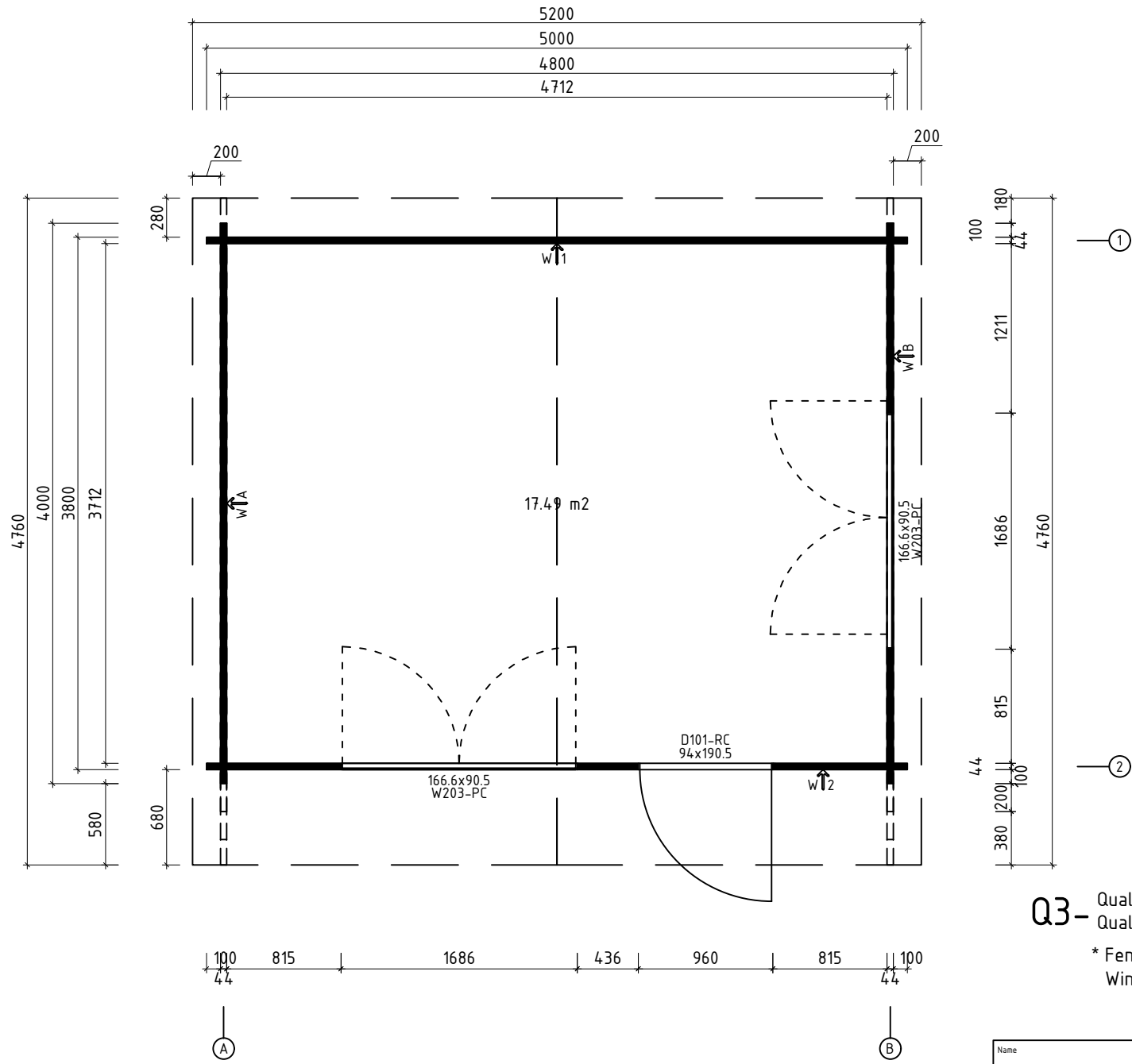



Q3- Qualitätsklasse für Fenster und Türen/
Quality class for windows and doors



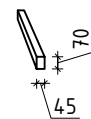
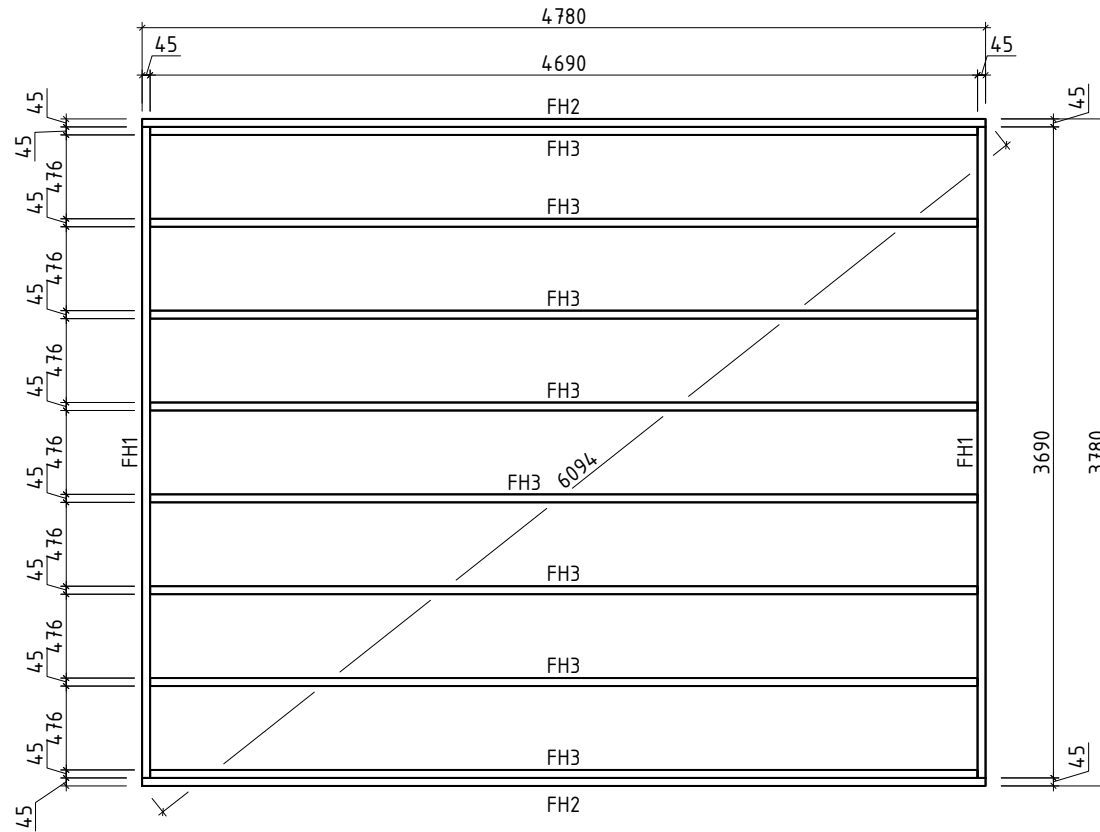



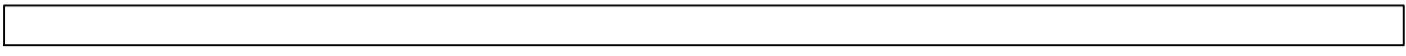
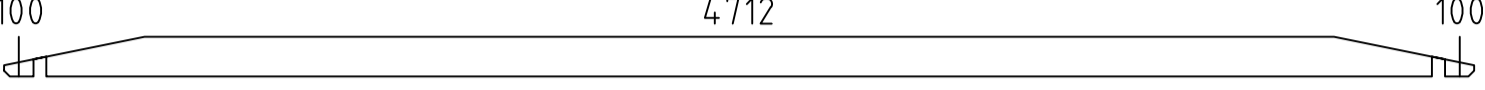
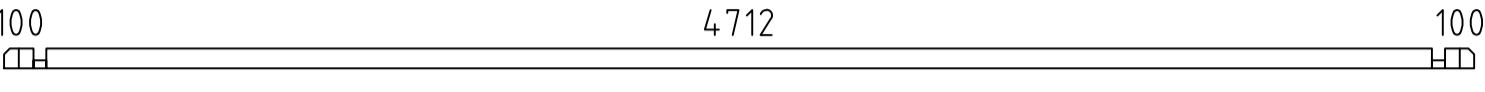
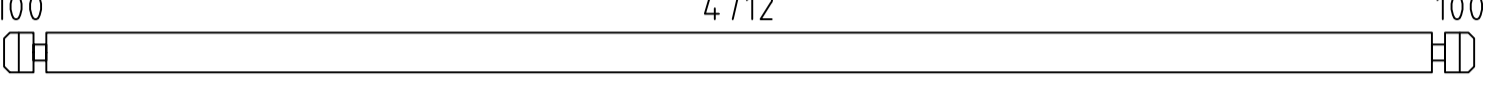

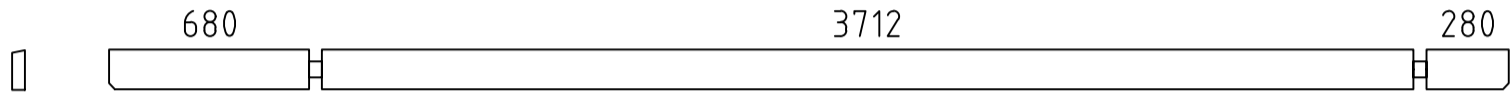
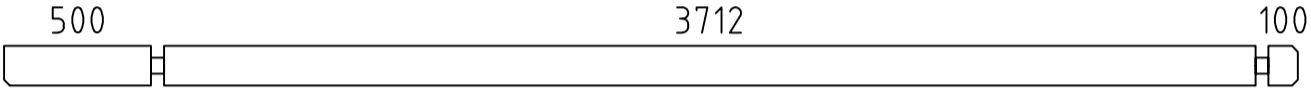
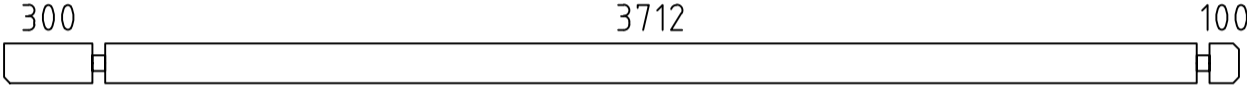
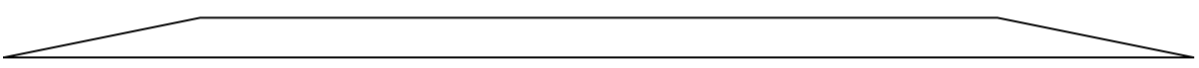
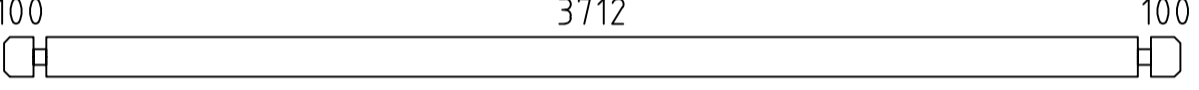
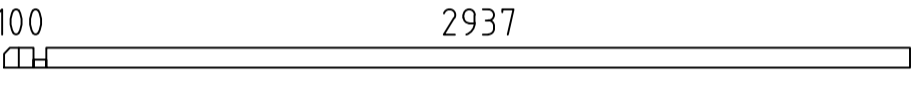
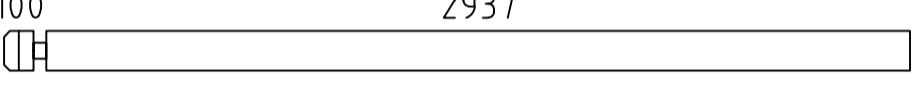
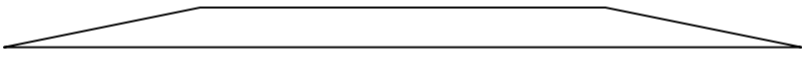
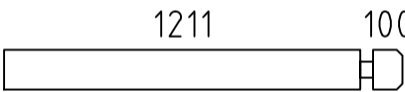
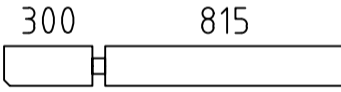
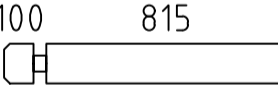
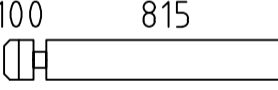
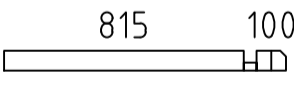
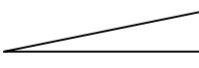
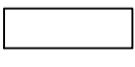
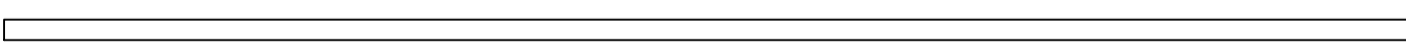
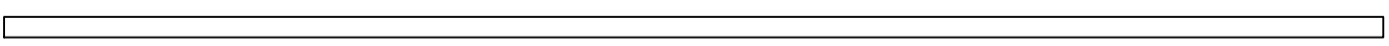
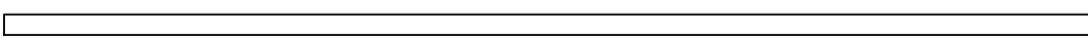
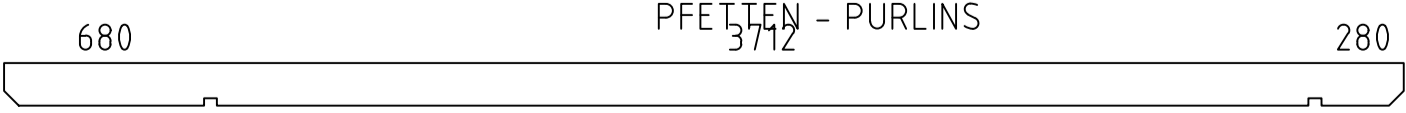
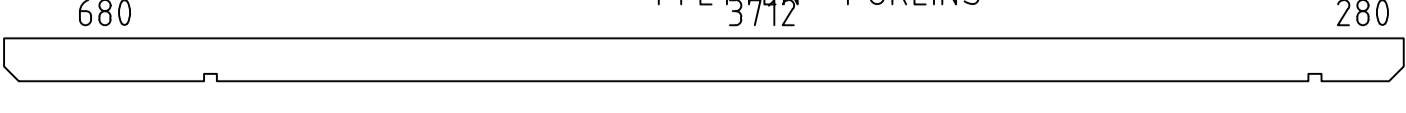

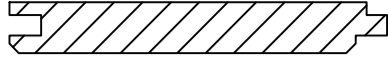
* Fenster und Türen sind mit Sprossen/
Windows and doors are with muntins

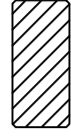
Name	VS44_0357 500x400/44		
Zeichnung/Drawing	Grundplan, Plan	VS44_0357	
Profil/Profile	4.4x13.5	Maßstab/Scale	1:30
Druck auf/Print on	A3	Datum/Date	06.04.2026

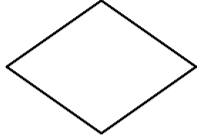
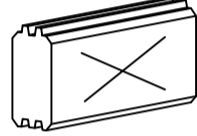

Name	VS44_0357 500x400/44		
Zeichnung/Drucktitel	Lagerholzplan, Foundation beams	VS44_0357	
Profil/Profile	4.4x13.5	Maßstab/Scale	1:30
Druck auf/Print on	A3	Datum/Date	06.04.2026

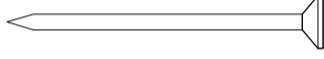
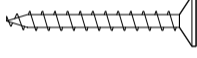
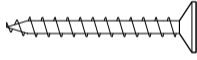
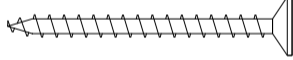
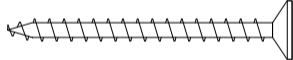
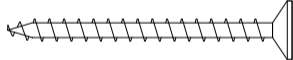
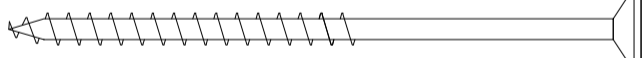
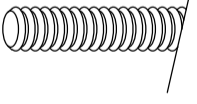
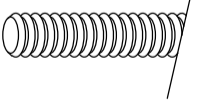
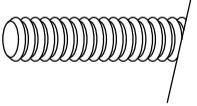
Pos	Teileliste/Specification VS44_0357 500x400/44	Pcs.	Profile (mm)	Length (mm)
	<u>Achtung!</u> Die Giebelbohlen können teilweise schon vormontiert sein! Bitte beachten - diese erscheinen nicht ganz so wie in der Teileliste beschrieben.			
	<u>Notice!</u> The gable pieces can be partly pre-assembled! Please notice - those differ from the description given in the specification list.			
1extra		1	44x135	5000
001		2	44x135	5000
002		1	44x68	5000
003		14	44x135	5000
004		1	44x135	4760
005		1	44x135	4760
006		2	44x135	4400
007		1	44x135	4200
008		2	44x135	4045
009		18	44x135	4000
010		1	44x68	3081
011		7	44x135	3081
012		2	44x135	2711
013		7	44x135	1355
014		1	44x135	1159
015		6	44x135	959
016		21	44x135	959
017		1	44x68	959
018		4	44x135	667
019		7	44x135	436
FH2	FUNDAMENTHOLZ (imprägniert) - FOUNDATION BEAM (impregnated) 	2	45x70	4780
FH3	FUNDAMENTHOLZ (imprägniert) - FOUNDATION BEAM (impregnated) 	8	45x70	4690
FH1	FUNDAMENTHOLZ (imprägniert) - FOUNDATION BEAM (impregnated) 	2	45x70	3690
PF1	PFETTEN - PURLINS 	4	44x145	4760
PF2	PFETTEN - PURLINS 	1	44x145	4760
Kood	VS44_0357 500x400/44	Materjal		Leht 1/4

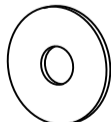
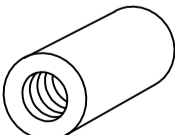
Pos	Teileliste/Specification VS44_0357 500x400/44		Pcs.	Profile (mm)	Length (mm)
	DACHBRETTER - ROOF BOARDS		86+1	113x16	2653
	FUSSBODENBRETTER - FLOOR BOARDS		42+1	113x18	3707
	FUSSBODENLEISTEN - FLOOR STRIPS	 ✓		18x40	19,0 lfm/rm
G02-1	GIEBELBRETTER - GABLE BOARDS 18x120	11,4°  ✓	4	18x120	2733
G06-1	GIEBELDECKLEISTEN - GABLE COVER STRIPS 18x58	 ✓	4	18x58	2733
T01-1	TRAUFENBRETTER - EAVES BOARDS 18x95		2	18x95	4760
T06-1	TRAUFENLEISTEN - EAVES STRIPS 18x40	 ✓		18x40	10,0 lfm/rm
GS	GIEBELSEGMENT - GABLE DIAMOND		2		
SH	SCHLAGHÖLZER - MOUNTING PIECES		3		
NG2 550	NÄGEL - NAILS 2.5x50 Dachbretter - Roof boards		688		
NG2 550	NÄGEL - NAILS 2.5x50 Fussbodenbretter - Floor boards		672		
SR3 030	Schrauben - Screws 3.0x30 Fussbodenleisten - Floor strips		38		
SR3 030	Schrauben - Screws 3.0x30 Traufenleisten - Eaves strips		22		
SR3 545	Schrauben - Screws 3.5x45 Giebelbretter - Gable boards		24		
SR3 545	Schrauben - Screws 3.5x45 Giebeldeckleisten - Gable cover strips		24		
SR3 545	Schrauben - Screws 3.5x45 Traufenbretter - Eaves boards		22		
SR5 0100	Schrauben - Screws 5.0x100 Fundamenthölzer - Foundation beams		48		
KL1	Gewindestange - Threaded Rod M8		4		2000
KL2	Gewindestange - Threaded Rod M8		2		123
KL3	Gewindestange - Threaded Rod M8		2		93
KV M UT M8	Mutter - Nut M8		8		
KV S EIB M8X25	U-Scheibe - Washer M8 Ø25		8		
KV MU TJ M8	Befestigungsmutter - Fixing nut M8		4		
	✓ - Bitte selber anpassen (falls nötig)! / Cut into length on site (if needed)!				
Kood	VS44_0357 500x400/44		Materjal		Leht 2/4

Aken	Q4-Q6	-	paigaldusjuhhis
Window	Q4-Q6	-	assembly instructions
Fenster	Q4-Q6	-	Montageanleitung

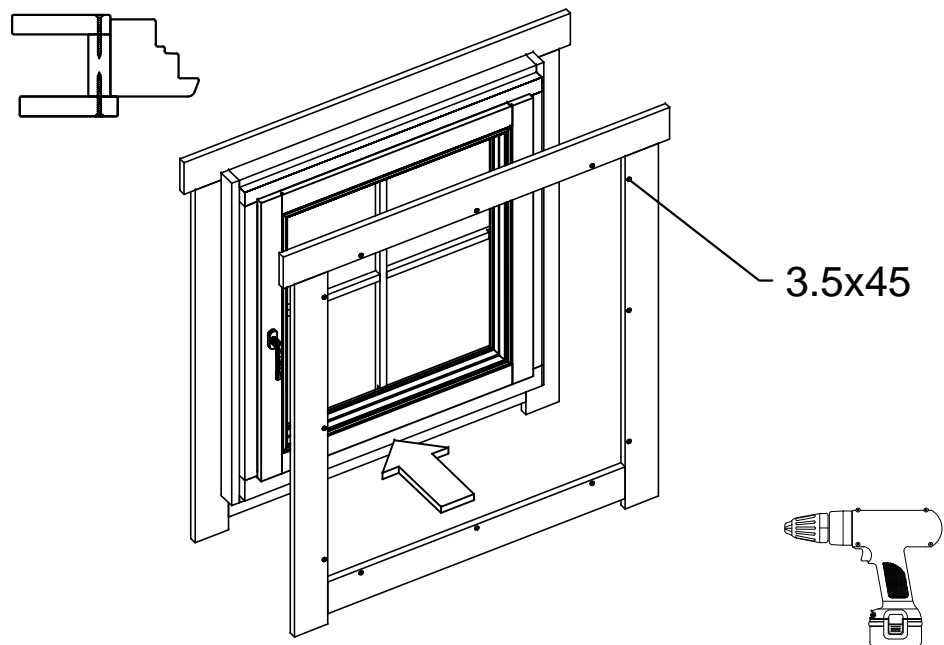
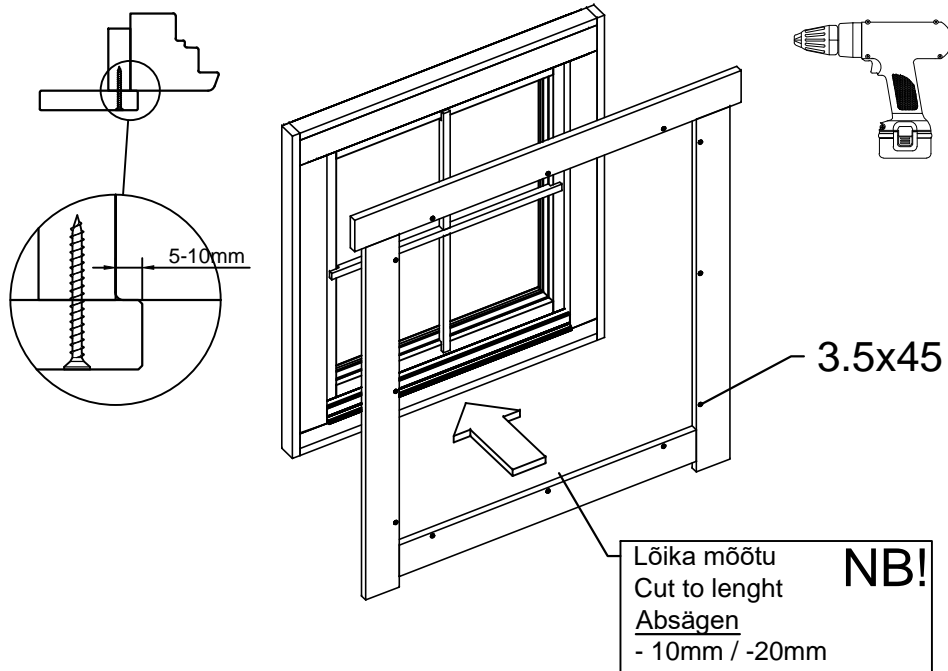
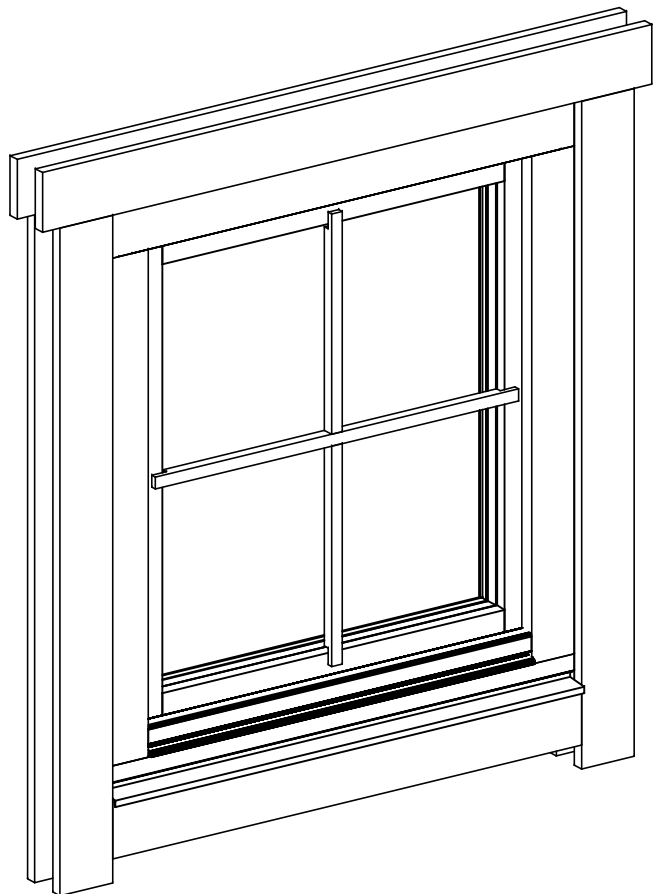

- Giebeldeckleisten
- Gable cover strips
- Dachbretter
- Roof boards 16x113
- Giebelbretter
- Gable boards
- Pfetten/Wandbohlen
- Purlins/Wall log

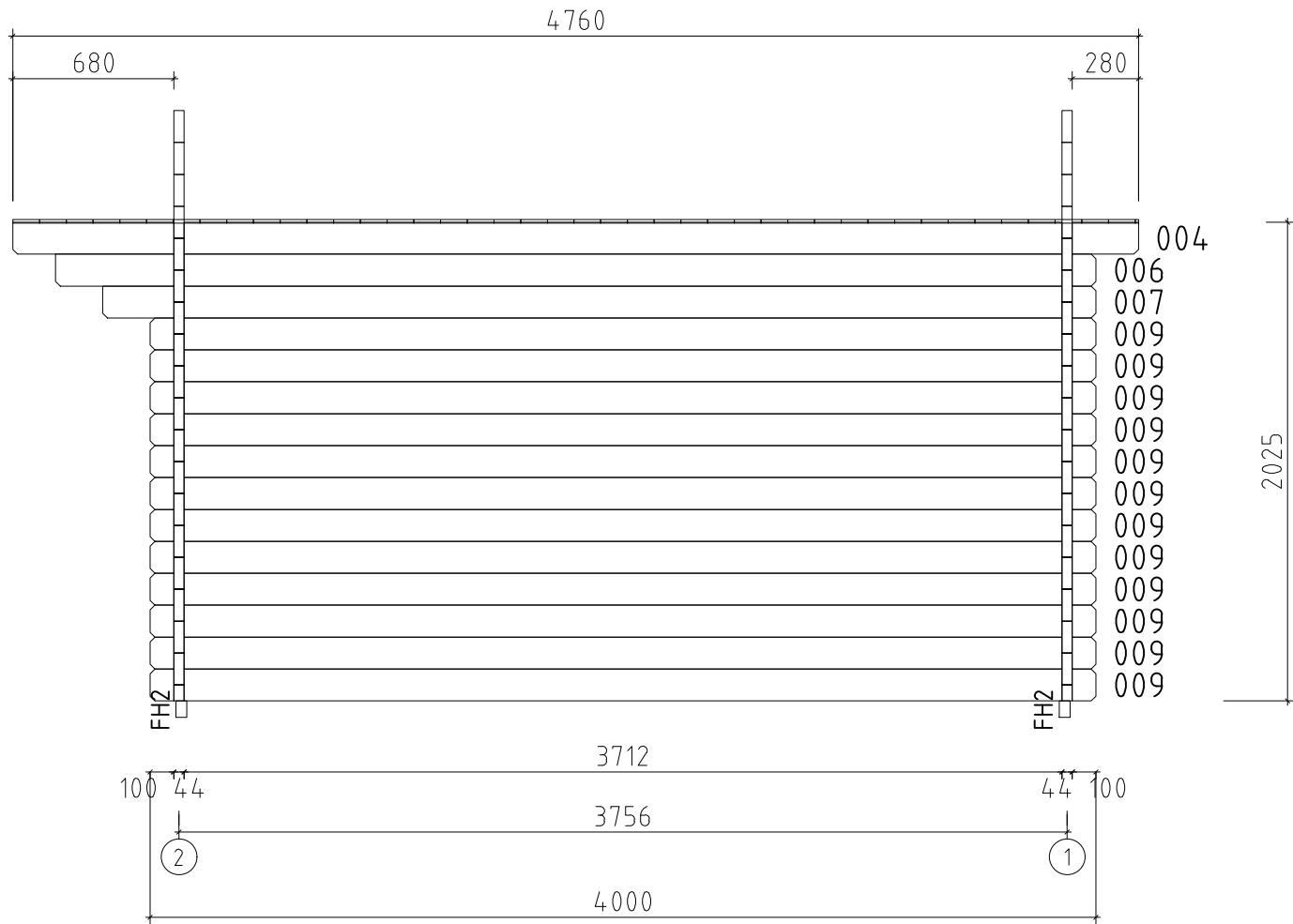

Wand/Wall A ↗

Name VS44_0357 500x400/44			
Zeichnung/Drawing WAND/WALL A		VS44_0357	
Profil/Profile 4.4x13.5	Maßstab/Scale 1:30	Druck auf/Print on A4	Datum/Date 06.04.2026

Wand/Wall B ↗

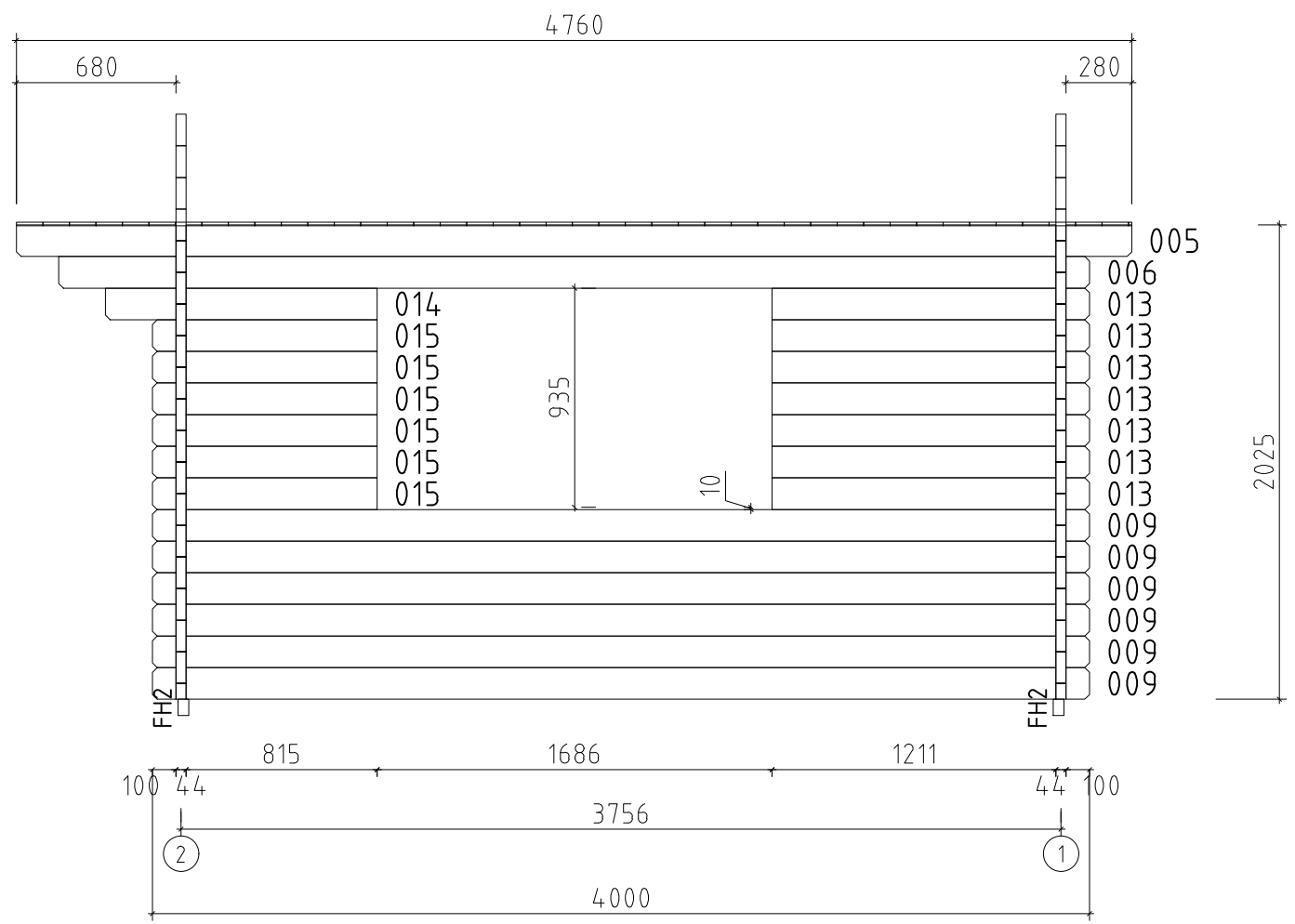

Name VS44_0357 500x400/44			
Zeichnung/Drawing WAND/WALL B		VS44_0357	
Profil/Profile 4.4x13.5	Maßstab/Scale 1:30	Druck auf/Print on A4	Datum/Date 06.04.2026

- Dachbretter
- Roof boards
- Traufenbretter
- Gable boards
- Traufenleisten
- Eaves strips

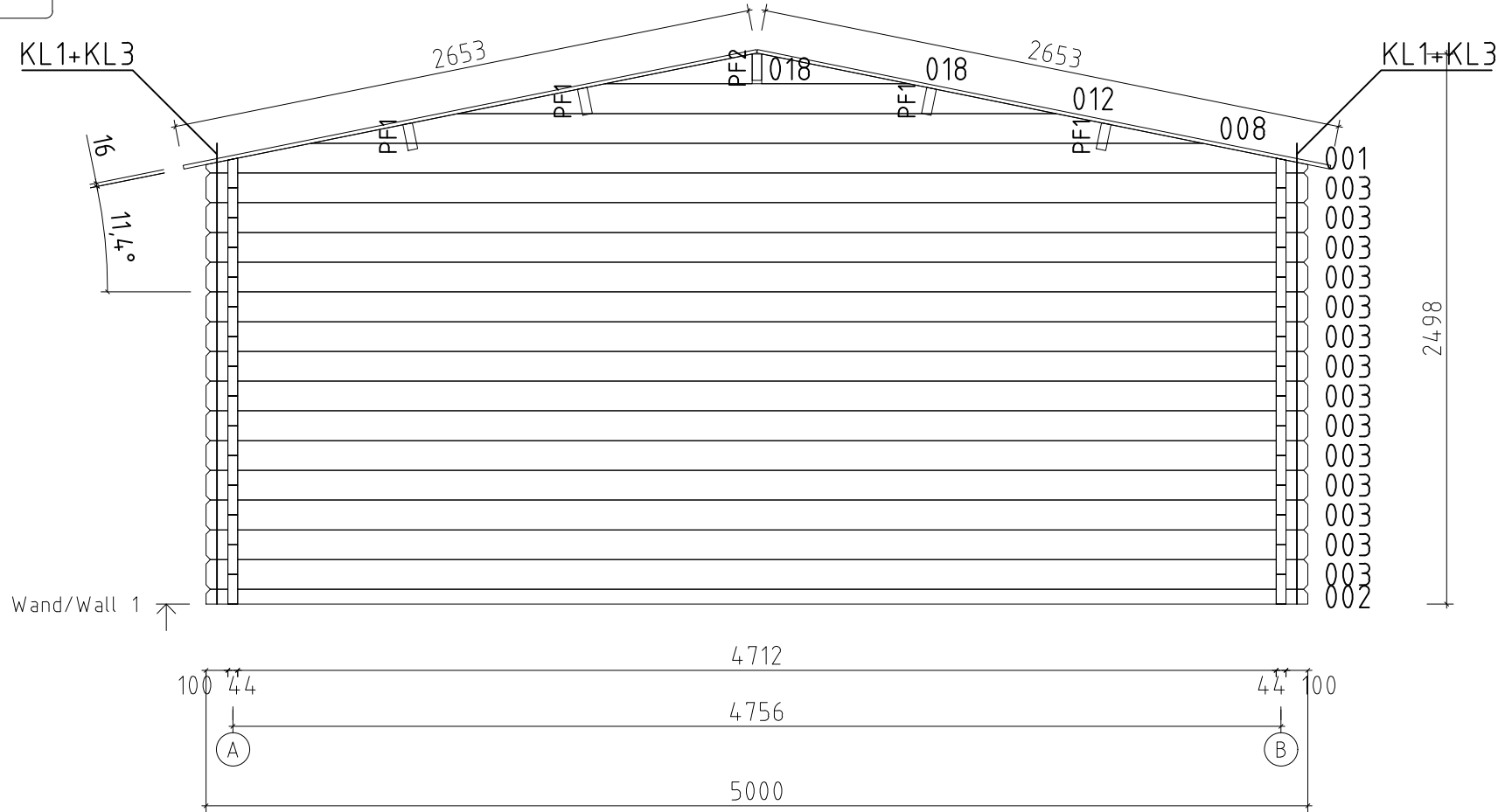

Name VS44_0357 500x400/44			
Zeichnung/Drawing WAND/WALL 1		VS44_0357	
Profil/Profile 4.4x13.5	Maßstab/Scale 1:30	Druck auf/Print on A4	Datum/Date 06.04.2026

