

Art. Nr. 2837500

1/7



28.06.2018

Groundplan - Grundplan - Plan de masse - Planimetria - Plattegrond - Põhiplaan

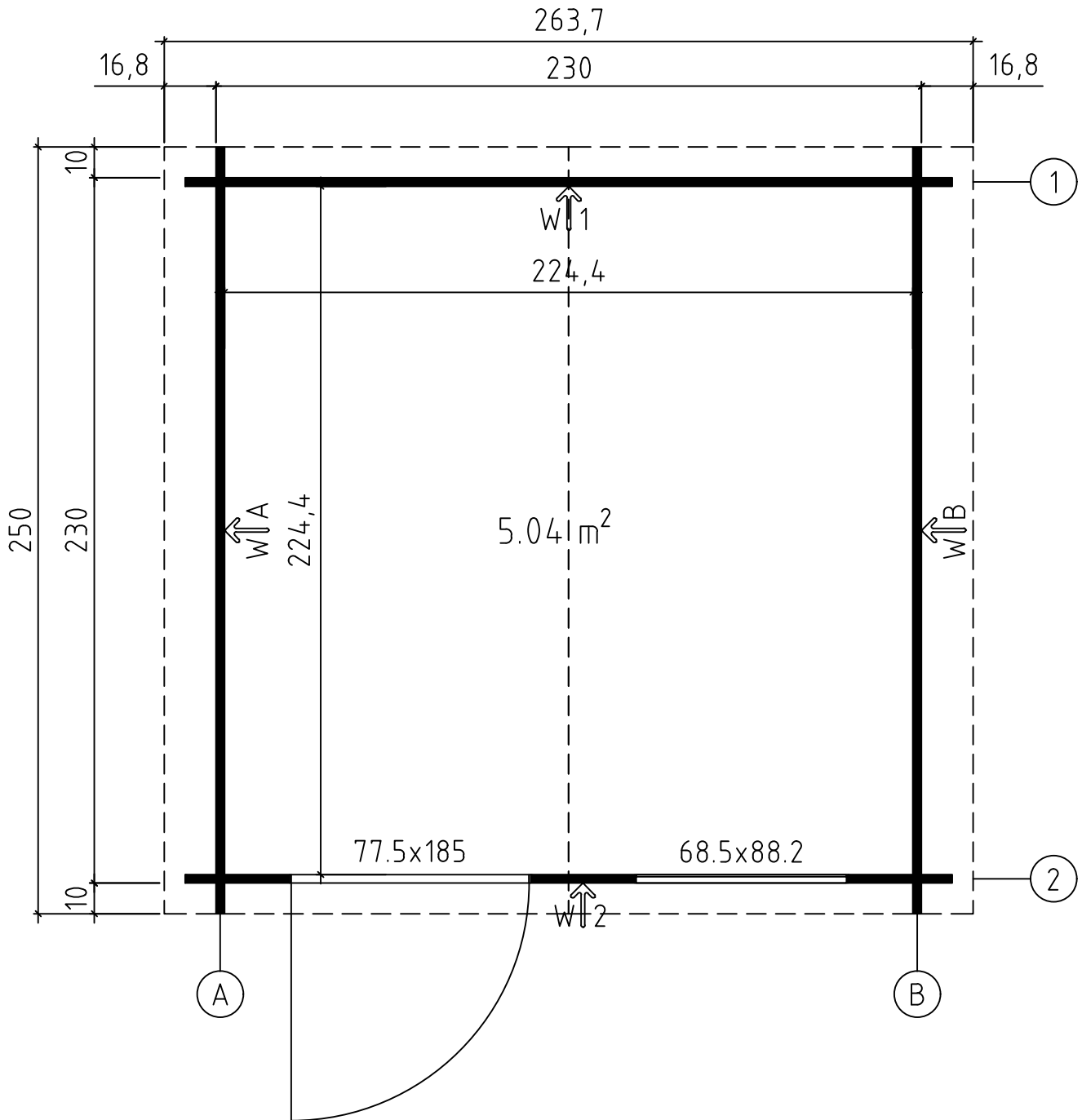

Art.Nr. 2837500

Foundation - Fundament - Fondation - Fundamenta - Fundering - Immutatud  
alusraam

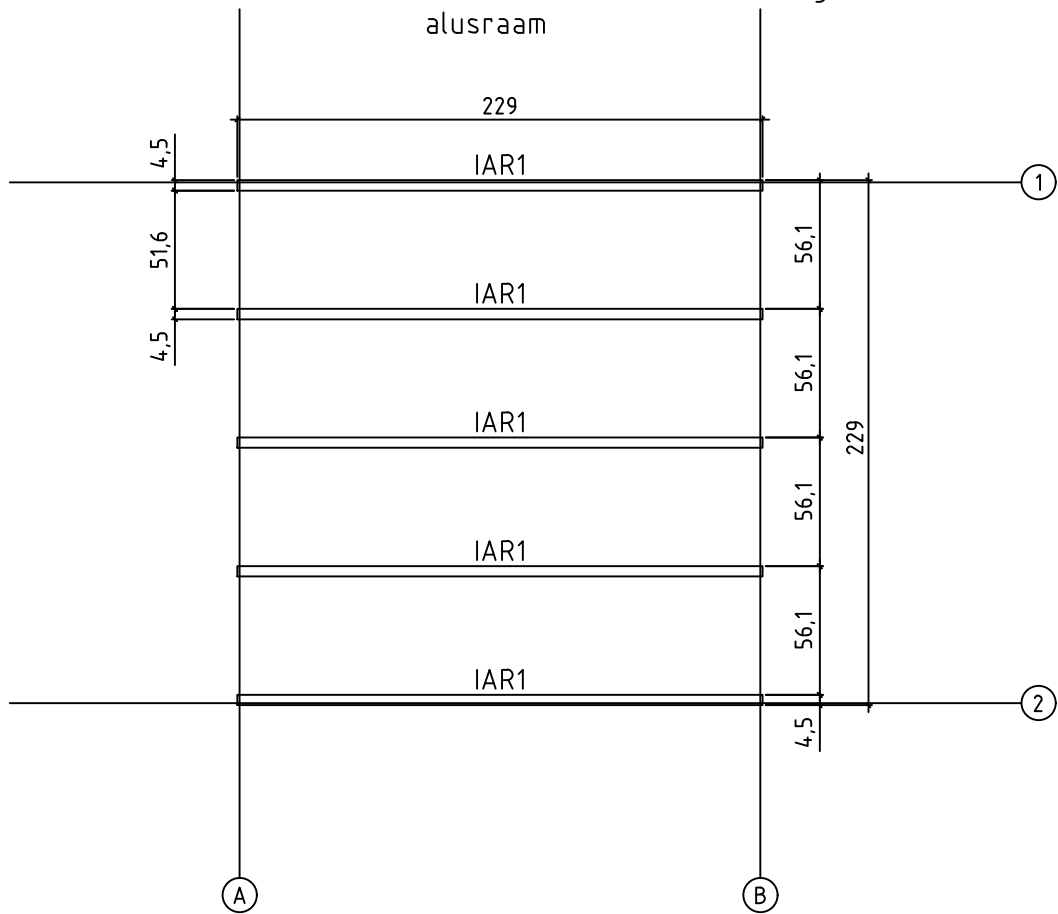



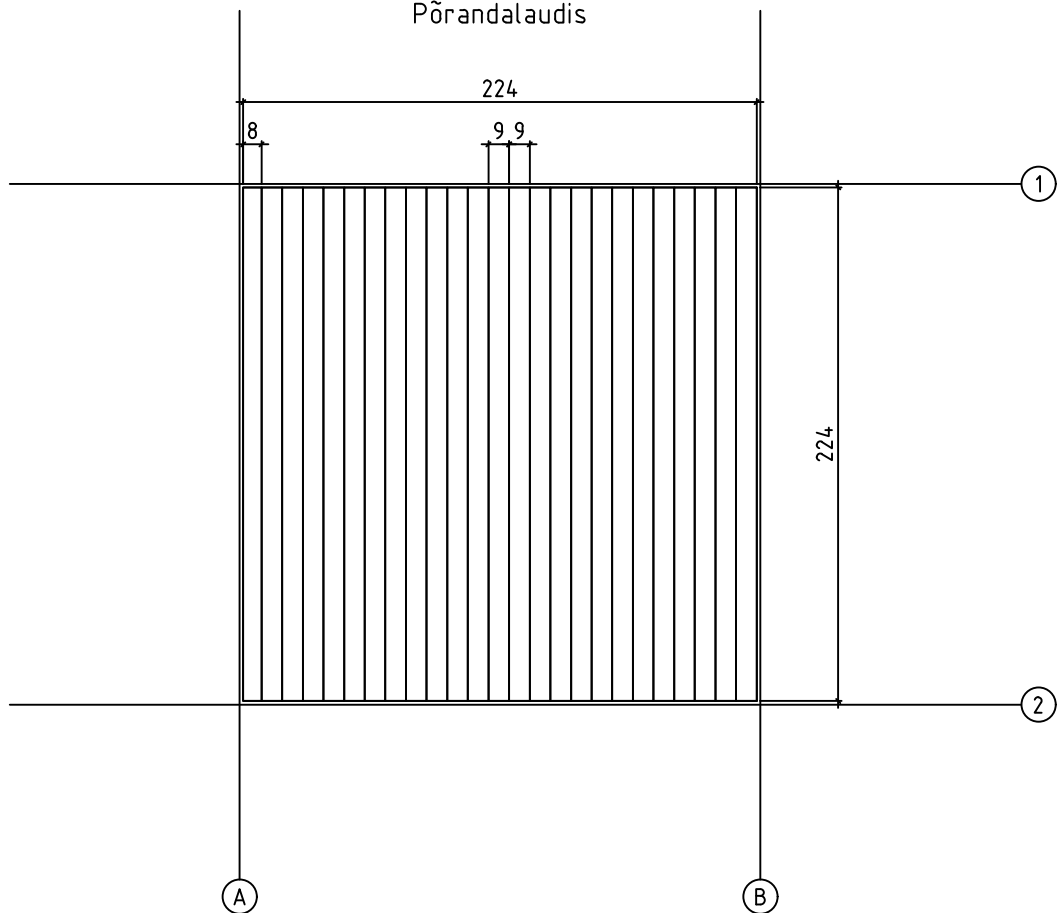

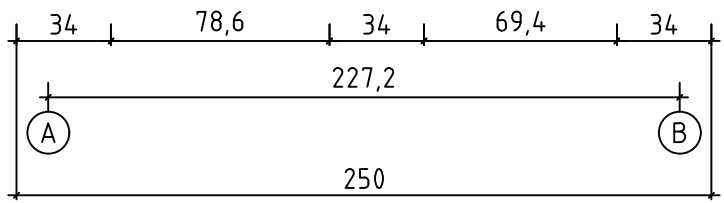
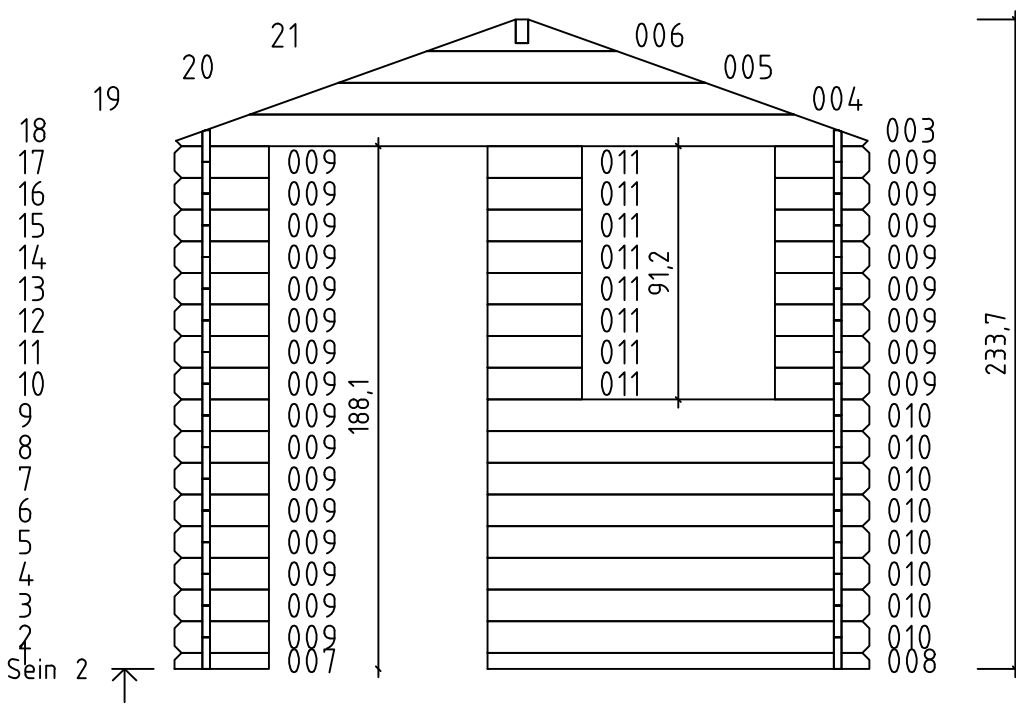
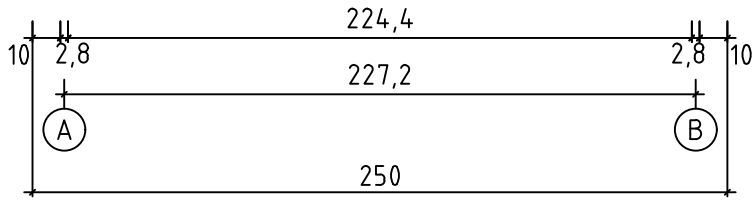
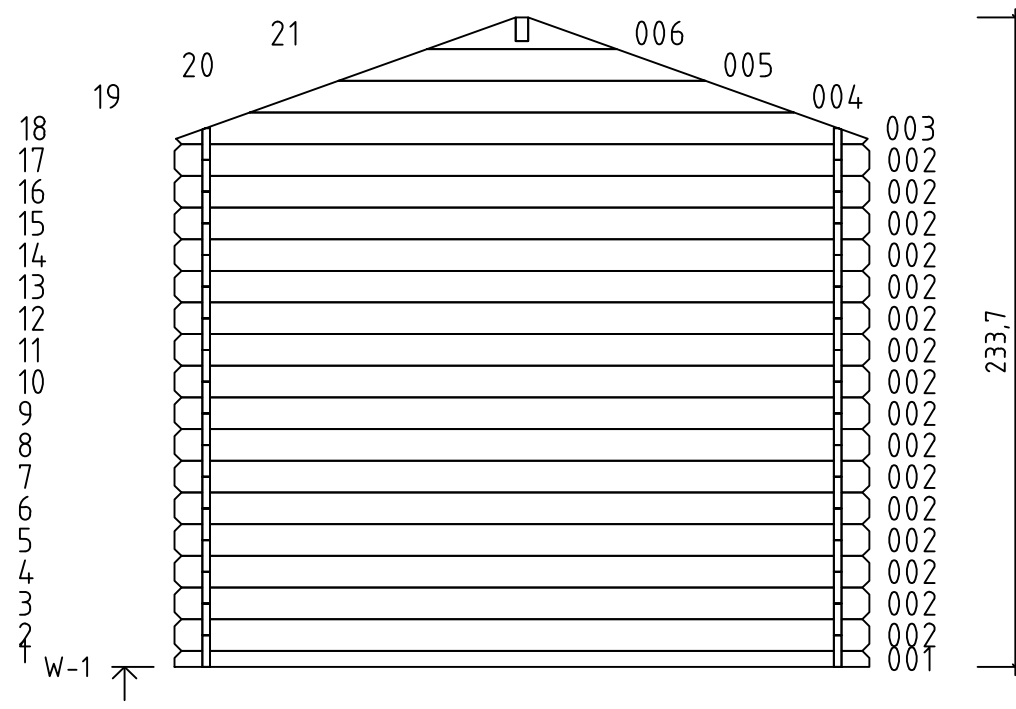



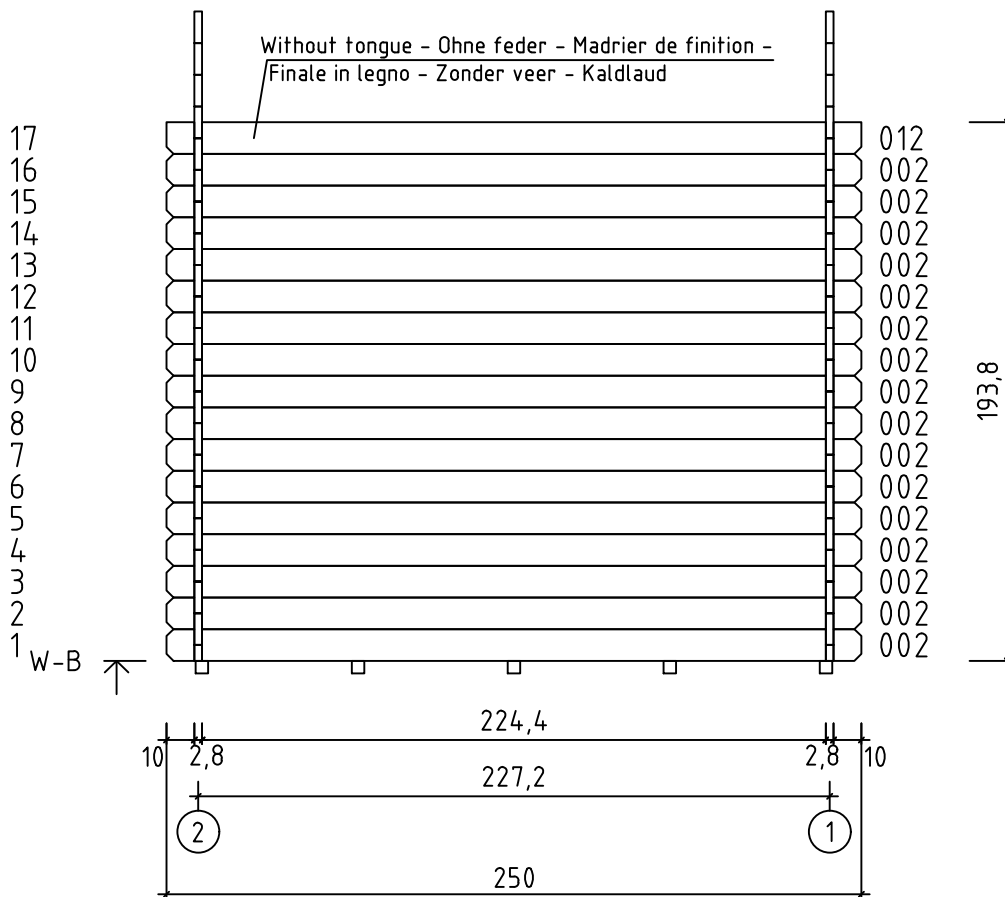
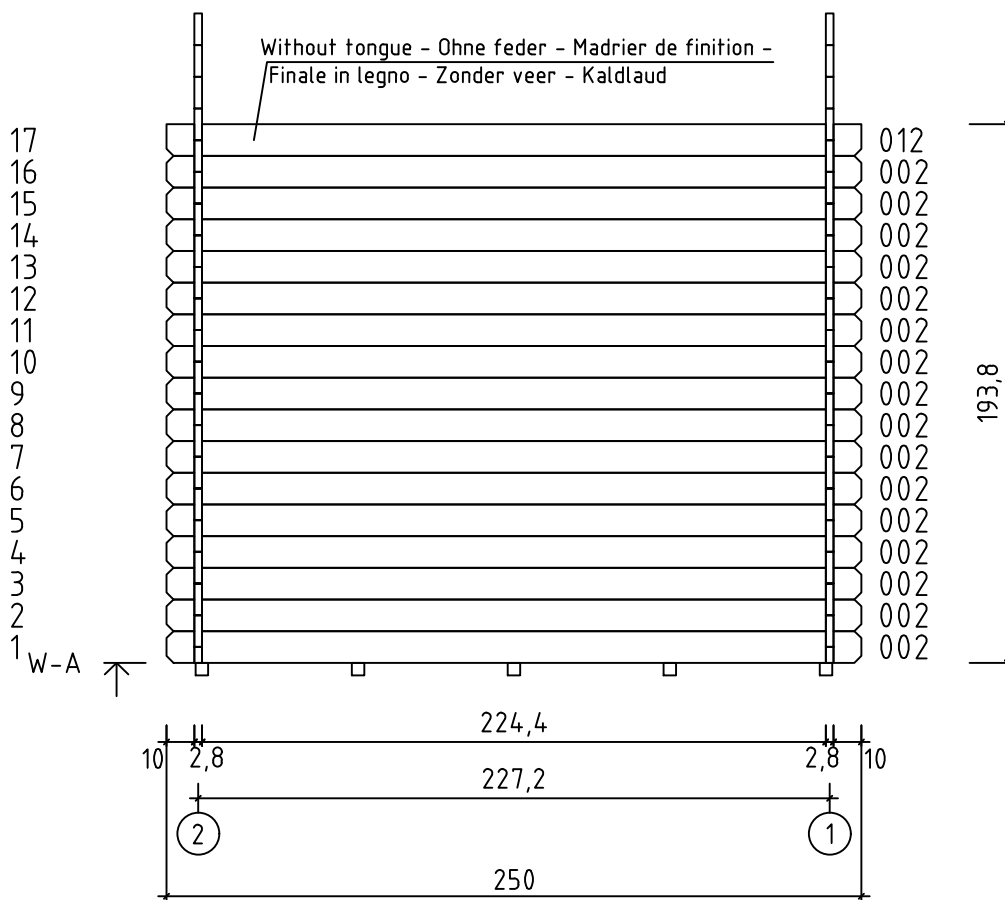

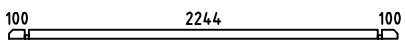
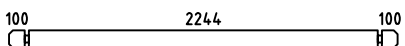

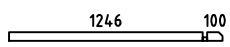

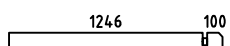
Floor boards - Fussbodenbretter - Plan pose plancher - Pavimento - Vloerhout -  
Põrandalaudis

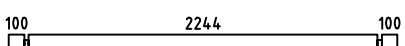
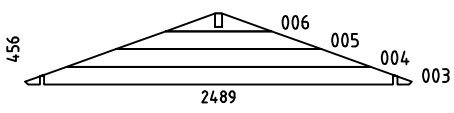
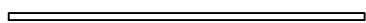
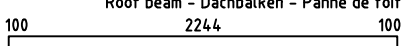
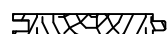
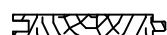

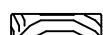

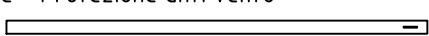
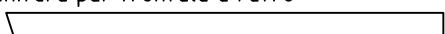







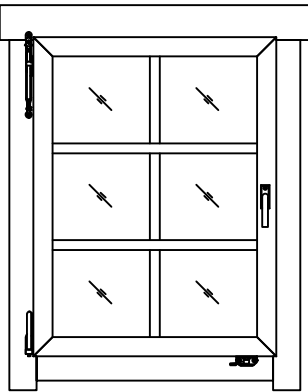
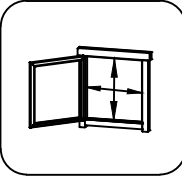

Art.Nr. 2837500

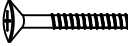
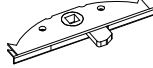

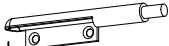
Pos	28.06.2018 Piece list - Stückliste - Liste des pièces - Elementi - Stuklijst - Tükitalabel Art.Nr. 2837500 6/7	Q	P (mm)	L (mm)
001		1	28x57	2500
002		48	28x114	2500
007		1	28x57	340
008		1	28x57	1374
009		24	28x114	340
010		8	28x114	1374
011		8	28x114	340
012		2	28x120	2500
W1-1 W2-1		1 1		
IAR1	Foundation - Fundament - Fondation - Fondamenta - Fundering - Immutatud alusraam 	5	45x45	2290
A-PR1	Roof beam - Dachbalken - Panne de toit - Perlina del tetto - Gordingen / dakbalk - Pärilin 	1	44x120	2500
	Floor boards - Fussbodenbretter - Lame de plancher - Pavimento - Vloerhout - Põrandalaud 	25	90x15	2240
	Roof boards - Dachbretter - Voliges - Perlina per tetto - Dakhout - Katuselaud 	56	90x15	1400
	Floor fillet - Fussbodenleiste - Corniere de finition du plancher - Finitura per pavimento (battisco pa) - Vloerafwerklijst - Põrandaliist 		18x18	8.96
	Roofing felt fillet - Dachpappenteiste - Baguette de fixation du feutre bitumeux - Asse per fissaggio guaina bituminosa - Afdeklijst asfaltpapier - Katusepapiiist 	4	15x45	1450
DRV-1	Roof edge reinforcement - Dachrandverstärkung - Corniere de renfort de bord de toit - Rinforzo x tetto - Dakrand versterking - Räästatugevdus 	2	15x45	2500
KFS-1	Storm protection - Sturmleiste - Latte anti-tempete - Protezione anti vento - Stormverankering / beveiliging - Tormikinnitusliist 	4	22x45	2050
	Gable moulding - Giebelleiste - Planche de rive - Finitura per frontale e retro del tetto - Gevellijst - Viilulaud 	4	15x120	1450
HS8	Screw for gable segment - Schrauben für deckblatt - Vis pour fixation losange de finition - Viti x frontali tetto - Schroef voor gevelpunt segment - Kruvi rombile 	4	3.5x35	
HS9	Screw for gable moulding - Schrauben für giebelleiste - Vis pour fixation planche de rive - Vite per fissare finiture davanti e dietro del tetto - Schroef voor gevellijst - Kruvi viilulauale 	16	3.5x50	
HS4	Screw for roof edge reinforcement - Schrauben für dachrandverstärkung - Vis pour fixation corniere renfort de bord de toit - Viti x rinforzo bordo tetto - Schroef voor dakrand versterking - Kruvi räästatugevdusele 	12	3x30	
HS18	Screw for roof beams - Schrauben für dachbalken - Vis pour fixation pannes de toit - Viti per perline del tetto - Schroef voor gordingen / dakbalken - Kruvi pärlinitele 	2	5x120	

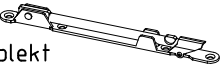
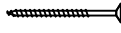
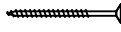
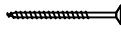

Pos	19.12.2017	Piece list - Stückliste - Liste des pièces - Elementi - Stuklijst - Tükitalabel 685x882 AK.1.106.SSV.d SGA	1/1	Q	P (mm)	L (mm)
		Glass size - Glasgröße - Taille de la vitre - Misura del vetro - Glas afmeting - Klaasi mõõt: 542x738 mm				
					585x782 mm	
1		Georgian bars - Sprossen - Croisillons - La griglia georgiana - Raamverdeling - Petteliistud		1	15x25	757
2		Georgian bars - Sprossen - Croisillons - La griglia georgiana - Raamverdeling - Petteliistud		2	15x25	576
FS1		Window handle fittings - Fenstergriff - Poignée de fenetre - Maniglia c/ferramenta - Raamhendel -/grendel -/klink - Aknalink		1		
FSP		Bolt for window handle fittings - Bolzen für fenstergriff beschlag - Vis pour fixation poignée de fenetre - Bullone x apertura manuale finestra - Schroef voor raamhendel - Akna käepideme polt		2		
FSL		Window closer - Fenstergriff - Système de fermeture pour fenêtre - Serratura della finestra - Raamslotje - Akna sulguri südamik		1		
FSA		Window closer striker - Gegenstück für Fenstergriff - Entrebâilleur de fenetre - Attacco aggancio per serratura della finestra - Raam sluitplaatje - Akna luku vastus		1		
NA1		Tilt & turn window set - Dreh-Kipp-Beschlag für Fenster - Ensemble de fenêtres oscillo-battantes - Insieme per il fermo dell'oscillazione del battente della finestra - Draaikiep raamsetje - Kald-pöördsuluse komplekt		1		
NA2		Tilt & turn window set - Dreh-Kipp-Beschlag für Fenster - Ensemble de fenêtres oscillo-battantes - Insieme per il fermo dell'oscillazione del battente della finestra - Draaikiep raamsetje - Kald-pöördsuluse komplekt		1		
NA3		Tilt & turn window set - Dreh-Kipp-Beschlag für Fenster - Ensemble de fenêtres oscillo-battantes - Insieme per il fermo dell'oscillazione del battente della finestra - Draaikiep raamsetje - Kald-pöördsuluse komplekt		1		
NA4		Tilt & turn window set - Dreh-Kipp-Beschlag für Fenster - Ensemble de fenêtres oscillo-battantes - Insieme per il fermo dell'oscillazione del battente della finestra - Draaikiep raamsetje - Kald-pöördsuluse komplekt		1		
NA5		Tilt & turn window set - Dreh-Kipp-Beschlag für Fenster - Ensemble de fenêtres oscillo-battantes - Insieme per il fermo dell'oscillazione del battente della finestra - Draaikiep raamsetje - Kald-pöördsuluse komplekt		1		
NA6		Tilt & turn window set - Dreh-Kipp-Beschlag für Fenster - Ensemble de fenêtres oscillo-battantes - Insieme per il fermo dell'oscillazione del battente della finestra - Draaikiep raamsetje - Kald-pöördsuluse komplekt		1		
HS1		Screw for georgian bars - Schraube für sprossen - Vis pour croisillons - Viti per unire la griglia georgiana della finestra - Schroeven voor raamverdeling - Kruvi akna petteliistule		6	2.5x20	
HS31		Screw for window closer striker - Schraube für Gegenstück / Fenstergriff - Vis pour entrebâilleur de fenetre - viti per attacco della serratura della finestra - Schroef voor raam sluitplaatje - Kruvi akna luku vastusele		2	3.5x15	
HS10		Screw for tilt & turn window set - Schraube für Dreh-Kipp-Beschlag - Vis pour système oscillo-battant - Viti per attacco dell'insieme del fermo per oscillazione del battente della finestra - Schroeven voor draaikiepssetje - Kruvi kald-pöördsuluse komplektille		14	4x25	



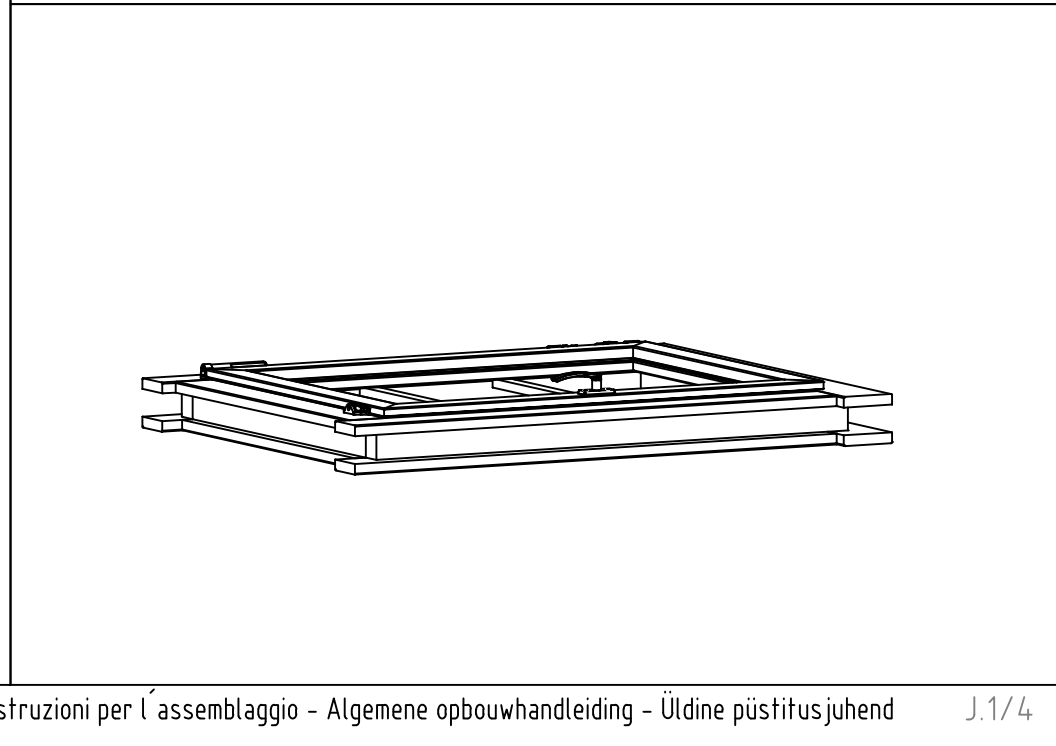

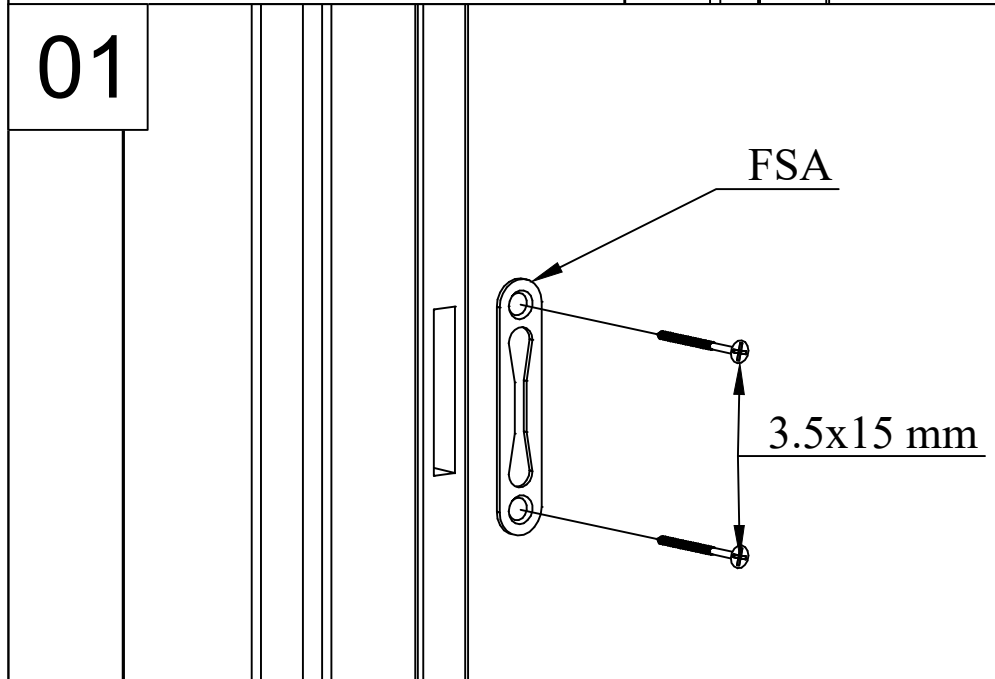

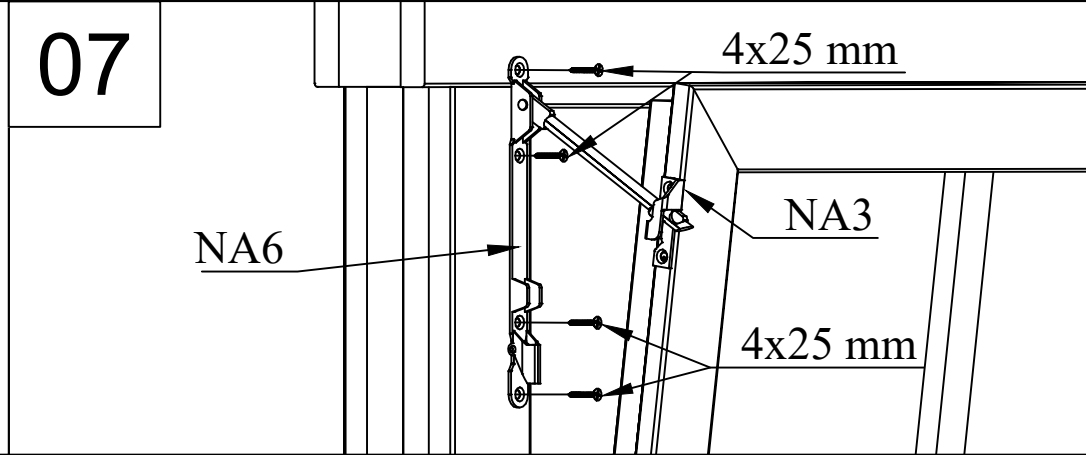
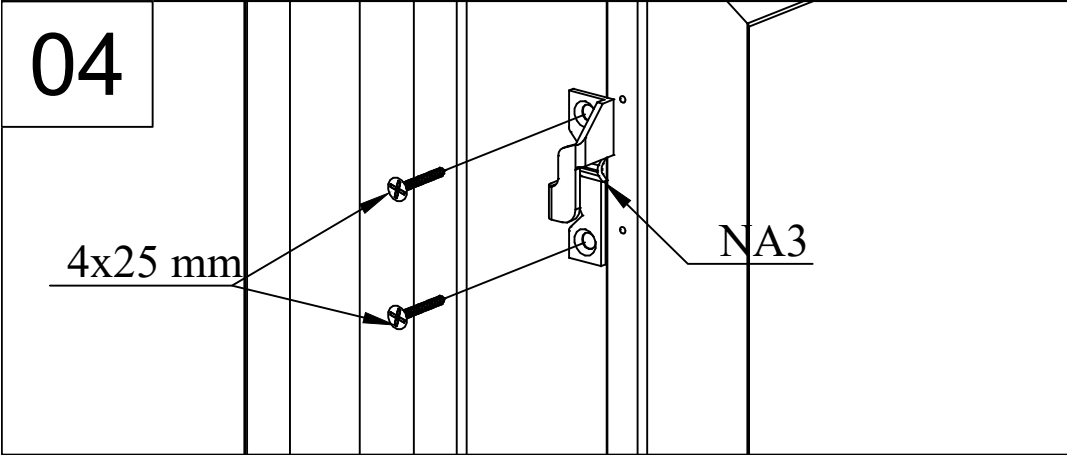



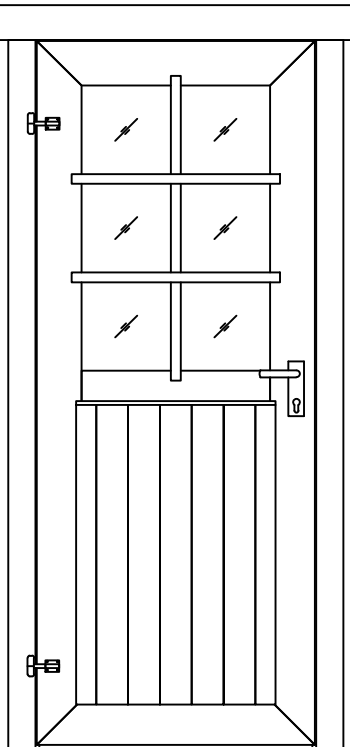
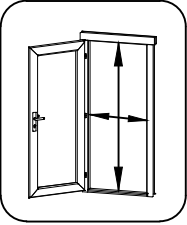



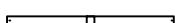

Pos	21.12.2017	Piece list - Stückliste - Liste des pièces - Elementi - Stuklijst - Tükitalabel 775x1850 UK.2.056.SVV.MMX28 SGA+28	1/2	Q	P (mm)	L (mm)
		Glass size - Glasgröße - Taille de la vitre - Misura del vetro - Glas afmeting - Klaasi mõõt: 502x750 mm				
		  <p>702x1793 mm</p>				
1	Upper door jamb - Türrahmen oben - Cadre de porte supérieur - Telaio superiore della porta - Bovendorpel - Ukse ülemine leng		1	66x100	912	
2	Left door jamb - Türrahmen links - Cadre de porte gauche - Telaio montante sinistro della porta - Linkerstijl deurframe - Ukse vasak leng		1	66x80	1850	
3	Right door jamb - Türrahmen rechts - Cadre de porte droit - Telaio montante destro della porta - Rechterstijl deurframe - Ukse parem leng		1	66x80	1850	
4	Doorstep - Swelle - Barre de seuil - Soglia della porta - Deurdorpel - Lävepak		1	20x21	702	
5	Georgian bars - Sprossen - Croisillons - La griglia georgiana - Raamverdeling - Petteliistud		1	15x25	784	
6	Georgian bars - Sprossen - Croisillons - La griglia georgiana - Raamverdeling - Petteliistud		2	15x25	536	



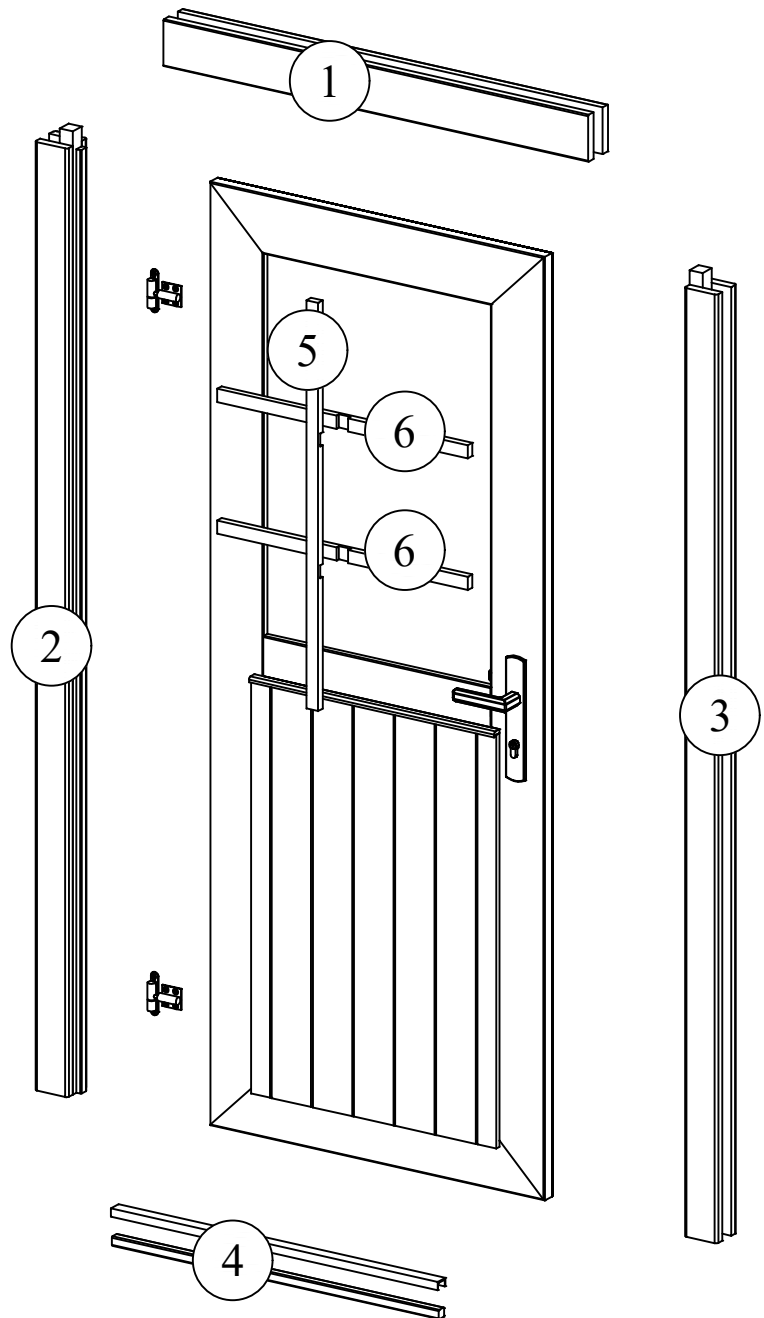

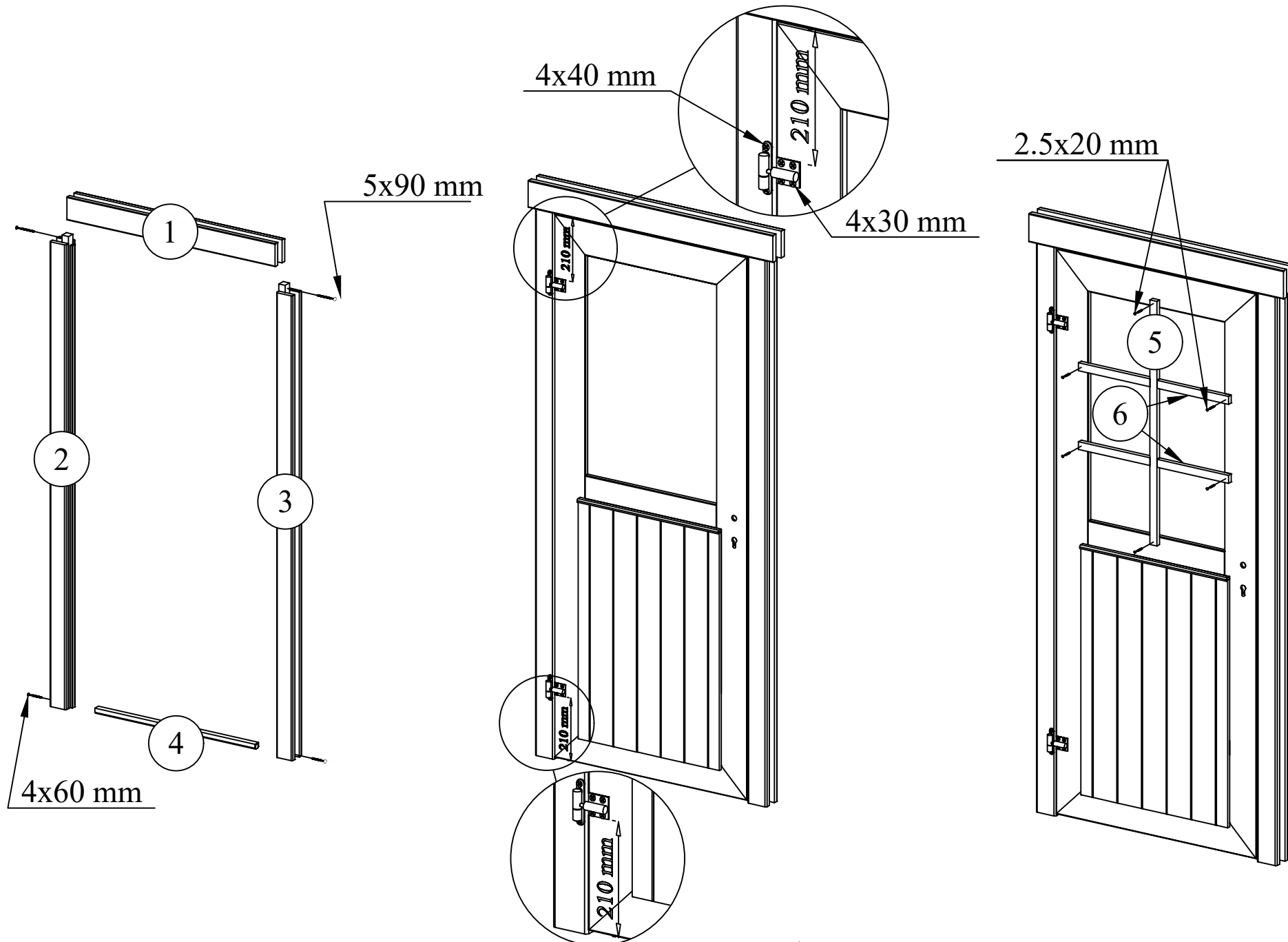





01

4x25 mm

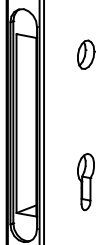
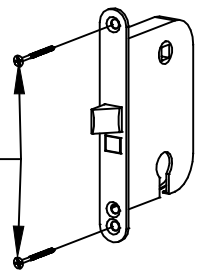

04

4x25 mm

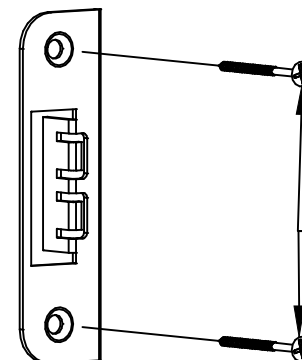

02

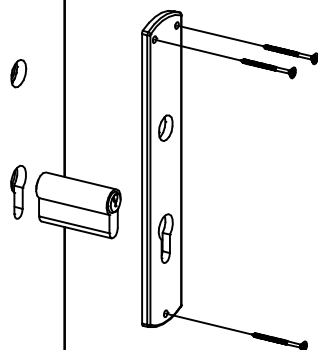
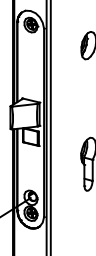
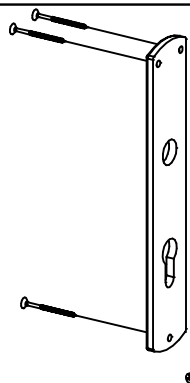

05

4.5x60 mm

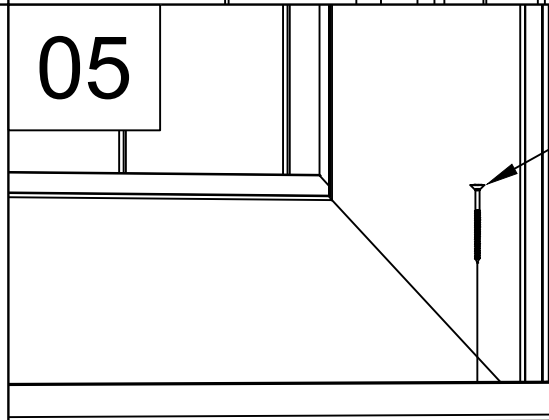

03

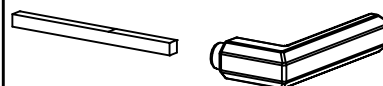
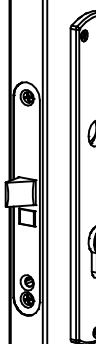
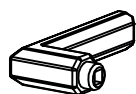

06

3.5x50 mm

